

# 4L40E 4 SPEED, 5L40E 5 SPEED (M82), 5L50E (M22) - ELECTRONIC - RWD

## REVERSE AND DIRECT CLUTCH HOUSING ASSEMBLY

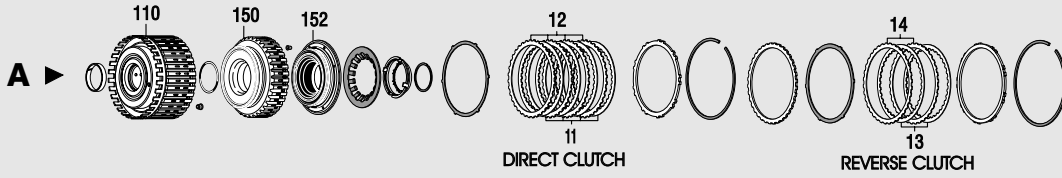

## FORWARD AND COAST CLUTCH HOUSING ASSEMBLY

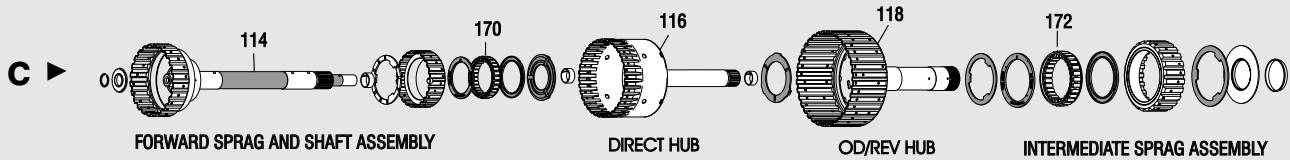
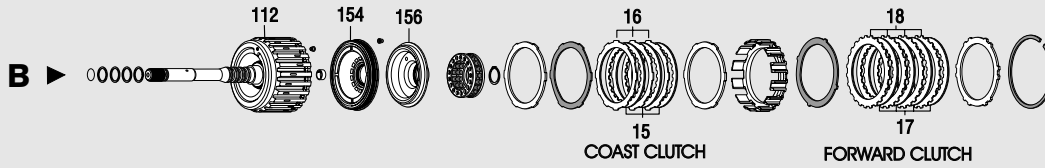

## INTERMEDIATE AND OVERDRIVE CLUTCH HOUSING ASSEMBLY

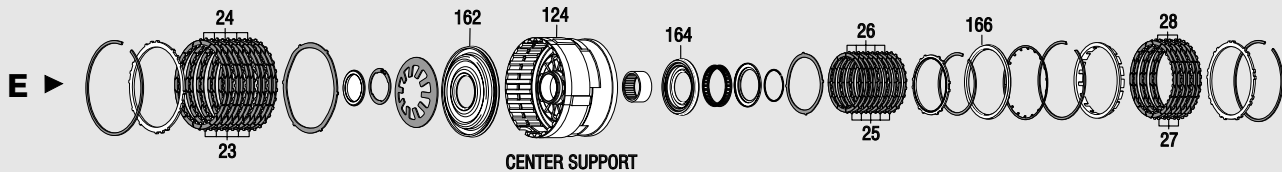
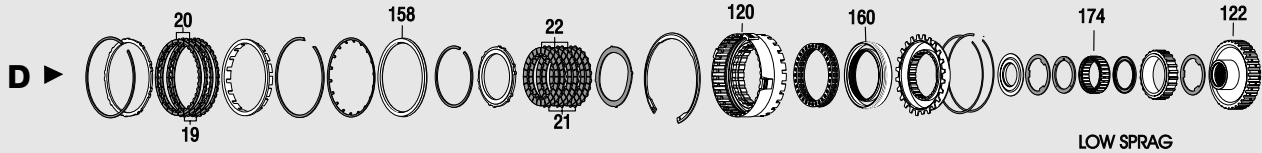

## 2ND SPRAG PLANETARY SYSTEM

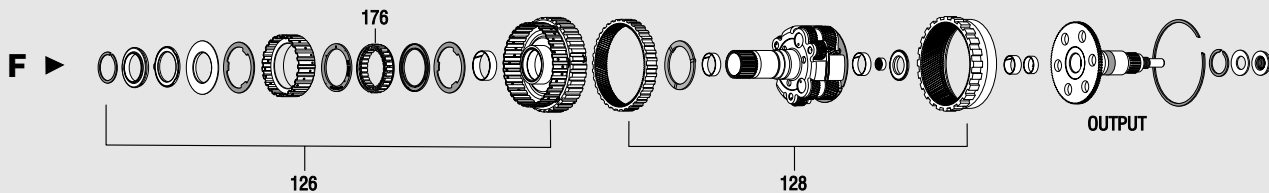

# 4L40E 4 SPEED, 5L40E 5 SPEED (M82), 5L50E (M22) - ELECTRONIC - RWD

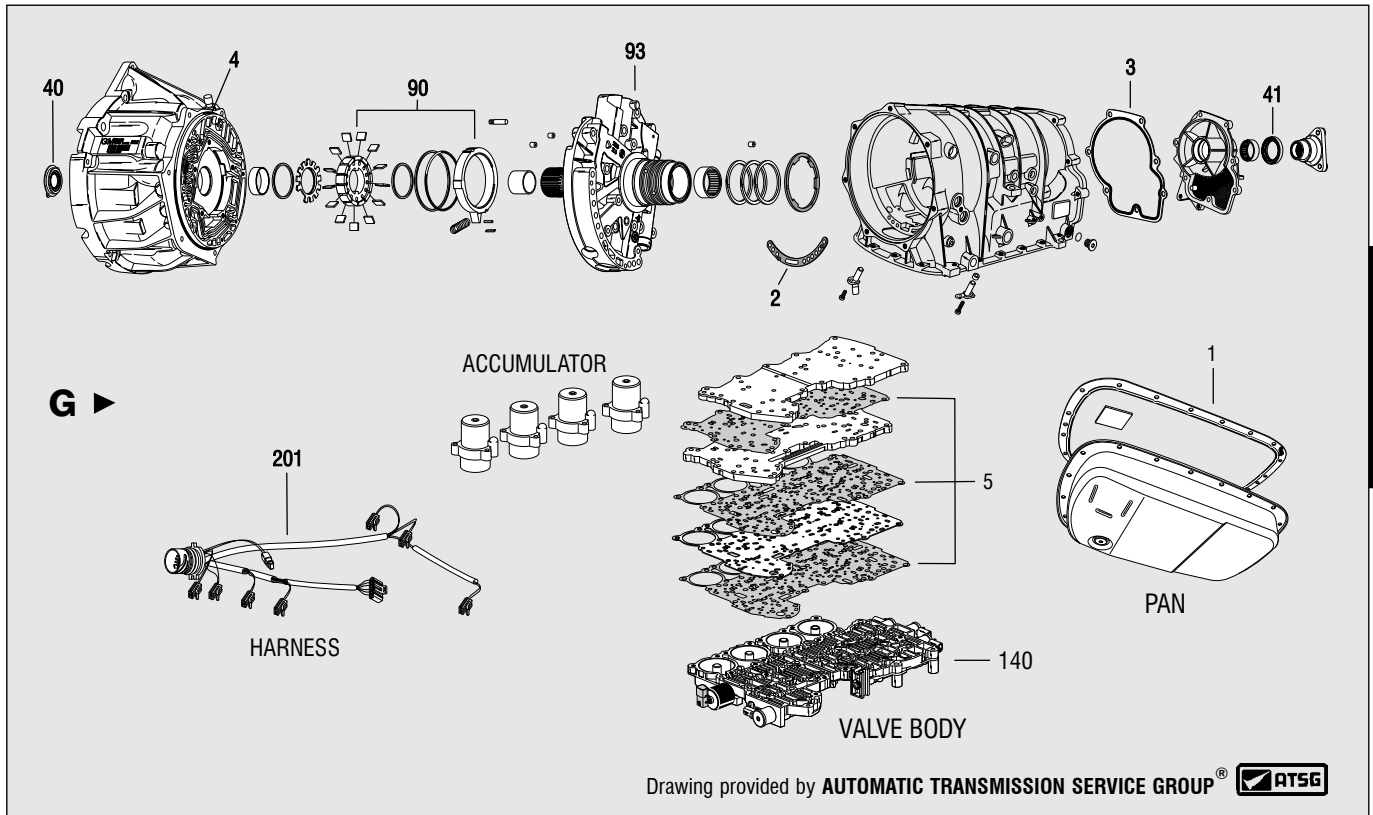

4L/5L40E/5L50E

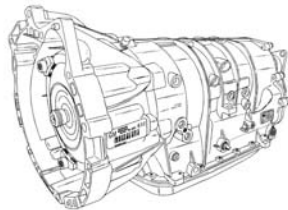

BMW (4L/5L40E)	99-Up
Cadillac CTS (5L40E)	03-Up
XLR (5L50E)	04-Up

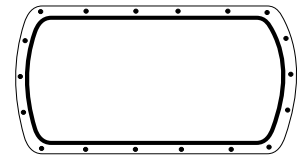

20 Bolt Pan

## REBUILDER KITS

			DELUXE	MASTER	LESS STEELS	OVERHAUL	GASKET &
<b>To order Kits with all Borg Warner frictions, use a "KB" prefix instead of the traditional "K" prefix.</b>							
Rebuilder Kit - 4 Spd - 4L40E	1	99-Up		K4100N	K4100N-LS	K41900M	
Rebuilder Kit - 5 Spd - 5L40E/5L50E	1	99-Up		K4100M	K4100M-LS	K41900M	

ILL.	DESCRIPTION	QTY.	YEAR	PART NO.	REFERENCE NO.
<b>MISCELLANEOUS GASKETS &amp; SEALS/PAN GASKETS</b>					
1G	Gasket - Oil Pan (Molded) .....	1	99-Up	<b>13600MR</b>	96041861
2G	Gasket - Front Pump To Case .....	1	99-Up	<b>13601M</b>	N.L.
3G	Gasket - Extension Housing .....	1	99-Up	<b>13927M</b>	N.L.
4G	Seal - Front Pump .....	1	99-Up	<b>13602M</b>	N.L.
5G	Gasket Package - Valve Body .....	1	99-Up	<b>K13616M</b>	N.L.

# 4L40E 4 SPEED, 5L40E 5 SPEED (M82), 5L50E (M22) - ELECTRONIC - RWD

ILL.	DESCRIPTION	QTY.	YEAR	PART NO.	REFERENCE NO.	
<b>CLUTCH PLATES</b>						
<b>Order Frictions with prefix: "B" for Borg Warner brand, "R" for Raybestos brand, and "J" for Dynax.</b>						
11A	Friction - 1 Sided Facing: - Direct CL - I.D. Tooth - .....	4-5	99-Up	41104M	N.L.	
12A	- Direct CL - O.D. Tooth - .....	4-5	99-Up	41105M	N.L.	
13A	- Reverse CL- I.D. Tooth - .....	2	99-Up	41100M	N.L.	
14A	- Reverse CL- O.D. Tooth - .....	2	99-Up	41101M	N.L.	
17B	- Forward CL - I.D. Tooth - .....	4	99-Up	41110M	N.L.	
18B	- Forward CL - O.D. Tooth - .....	4	99-Up	41111M	N.L.	
15B	- Coast CL - I.D. Tooth - .....	3	99-Up	41108M	N.L.	
16B	- Coast CL - O.D. Tooth - .....	3	99-Up	41109M	N.L.	
19D	- Overdrive CL - I.D. Tooth - .....	2-3	99-Up	41100M	N.L.	
20D	- Overdrive CL - O.D. Tooth - .....	2-3	99-Up	41101M	N.L.	
21D	- Intermediate CL - I.D. Tooth - .....	3-4	99-Up	41106M	N.L.	
22D	- Intermediate CL - O.D. Tooth - .....	3-4	99-Up	41107M	N.L.	
23E	- Low/Reverse CL - I.D. Tooth - .....	5-6	99-Up	41104M	N.L.	
24E	- Low/Reverse CL - O.D. Tooth - .....	5-6	99-Up	41112M	N.L.	
25E	- 2nd CL - I.D. Tooth - (5 Speed Only) .....	5-6	99-Up	41102M	N.L.	
26E	- 2nd CL - O.D. Tooth - (5 Speed Only) .....	5-6	99-Up	41103M	N.L.	
27E	- 2nd Coast - I.D. Tooth - (5 Speed Only) .....	3	99-Up	41104M	N.L.	
28E	- 2nd Coast - O.D. Tooth - (5 Speed Only) .....	3	99-Up	41105M	N.L.	
<b>FILTERS/FILTER KITS</b>						
<b>Order Filter Kits with 'FK' prefix for Cork &amp; Neoprene, 'FFK' prefix for Fibre.</b>						
N.I.	Filter Kit - Oil - w/o neck spacer, w/o 1/2" inlet (Shallow Pan) .....	1	99-Up	FK41800M	N.L.	
N.I.	Filter Kit - Oil - w/ neck spacer, w/o 1/2" inlet (Deep Pan) .....	1	99-Up	FK41800N	N.L.	
N.I.	Filter Kit - Oil - w/ neck spacer, w/ 1/2" inlet (Deep Pan) .....	1	99-Up	FK41800P	N.L.	
N.I.	Filter - Oil - w/o neck spacer, w/o 1/2" inlet (Shallow Pan) .....	1	99-Up	41800M	N.L.	
N.I.	Filter - Oil - w/ neck spacer, w/o 1/2" inlet (Deep Pan) .....	1	99-Up	41800N	N.L.	
N.I.	Filter - Oil - w/ neck spacer, w/ 1/2" inlet (Deep Pan) .....	1	99-Up	41800P	N.L.	
<b>METAL CLAD SEALS</b>						
40G	Front Pump .....	1	99-Up	41151F	96020366	
41G	Extension Housing .....	1	99-Up	41201F	96020744	
<b>HARD PARTS</b>						
<p>Hard Parts may only require the base number for OEM/Aftermarket New. A "N" suffix may also be required.            Use a "D" prefix for Delco, or a "-R" suffix for remanufactured. Exceptions are listed individually.            NOTE: A separate column is provided to indicate a primary or specific brand/type.</p>						
ILL.	DESCRIPTION	BRAND	QTY.	YEAR	PART NO.	REFERENCE NO.
90G	Pump - Rotor/Slide Kit .....		1	99-Up	K41201M	N.L.
93G	Pump Cover .....		1	99-Up	41424M	N.L.
110A	Direct/Reverse Housing .....	R	1	99-Up	41962M	N.L.
112B	Forward/Coast Housing .....	R	1	99-Up	41963M	N.L.
120D	Intermediate/Overdrive Housing .....	R	1	99-Up	41964M	N.L.
124E	Low/Reverse/2nd Clutch Housing - (5 Speed Only) .....	R	1	99-Up	41965M	N.L.
124E	Low/Reverse Housing - (4 Speed Only) .....	R	1	99-Up	41965BM	N.L.
114C	Forward Sprag/Shaft Assembly .....	R	1	99-Up	41970M	N.L.
116C	Direct Clutch Hub .....	R	1	99-Up	41972M	N.L.
118C	Overdrive/Reverse Hub - w/Intermediate Sprag .....	R	1	99-Up	41974M	N.L.
122D	Low Sprag Assembly .....	R	1	99-Up	41976M	N.L.
126F	2nd Sprag Assembly - (5 Speed Only) .....	R	1	99-Up	41978M	N.L.

